



**TRANSLATION OF ORIGINAL OPERATING AND
INSTRUCTION MANUAL
NEXT OVEN**

EKF 523 NT UD



Tecnoeka srl

via Marco Polo, 11
35010 Borgoricco
Padova - Italy

tel. +39.049.5791479
tel. +39.049.9300344
fax +39.049.5794387

info@tecnoeka.com
tecnoekasrl@pec.it
tecnoeka.com

cod. fisc. - p.iva 00747580280
rea n. 133205
reg. a.e.e. n. IT08020000001275
cap. soc. euro 119.000,00 I.V.



EU DECLARATION OF CONFORMITY

Annex II A, of Directive 2006/42/EC

Manufacturer's name	TECNOEKA Srl
Manufacturer's address	Via Marco Polo, 11 - 35010 Borgoricco (PD)
Name of the person in charge of the technical file	Imazio Oscar
Address of the person in charge of the technical file	Via Marco Polo, 11 - 35010 Borgoricco (PD)
Product type	Electric oven
Purpose of the product	Cooking food
Model	EKF 523 NTUD
s/n	

TECNOEKA Srl declares that the above mentioned products comply with all provisions pertaining to the following directives:

Machinery directive 2006/42/EC;
Electromagnetic compatibility 2014/30/EU;

TECNOEKA Srl declares that the above mentioned products comply with the following harmonised directives:

EN 60335-1 ; EN 60335-2-42
EN 55014-1 ; EN 55014-2 ; EN 61000-3-2 ; EN 61000-3-3 ;
EN 62233

TECNOEKA Srl declares that the above-mentioned products also comply with the following directives:

General product safety directive 2001/95/EC;
Directive restricting the use of hazardous substances in electrical and electronic equipment 2011/65/EU;
Directive on waste electrical and electronic equipment 2012/19/EU.

TECNOEKA Srl declares that the above mentioned products comply with Regulation (EC) 1907/2006

TECNOEKA Srl declares that the above mentioned products comply with Regulation (EC) 1935/2004

Borgoricco, 09/05/2022.

Signature of the Board Representative (Lora Cristina)

INDEX

1. TECHNICAL SERVICE	5
2. INSTRUCTIONS FOR THE INSTALLER	5
2.1 Storage	5
2.2 Transportation of the appliance	5
2.3 Unpacking the appliance	5
2.4 Removal of the protective film	6
2.5 Protective film/package disposal	6
2.6 Placement	6
2.6.1 Table top oven placement	6
2.7 Electrical connection	7
2.8 Power supply cable connection (replacement)	7
2.9 Connection to the water mains	8
2.10 Water drain	8
2.10.1 Water drain for tabletop ovens	9
2.11 Steam drain	9
3. USER INSTRUCTIONS	9
3.1 Ignition	9
3.2 Touch Screen Control Operation	10
3.3 COOKING PARAMETERS SCREEN	10
3.3 PREHEATING SETTING	11
3.4 SETTING THE COOKING TIME	12
3.4 SETTING THE COOKING PHASES	12
3.5 SETTING OF COOKING TEMPERATURE	12
3.6 SETTING THE CORE TEMPERATURE	13
3.7 HUMIDITY SETTING	14
3.8 FAN SPEED SETTING	14
3.8 DELAYED START SETTING	14
3.9 STARTING/STOPPING THE COOKING CYCLE	14
3.10 Recipe book	15
3.11 Saving the new recipe	16
3.12 Deleting a recipe	16
3.13 Import/Export" with USB stick	16
3.13.1 "Exporting" recipes (saved programs)	16
3.13.2 "Importing" recipes (saved programs)	16
3.14 Cooling	17
3.15 Settings menu	18
3.15.1 Date and Time	18
3.15.2 Units of measurement	19
3.15.3 Information menu	19
3.15.4 Screen theme	19
3.15.5 Import/Export	20
3.15.6 "HACCP" function	20
3.15.7 Display (on PC) of HACCP data	20
3.16 Wi-Fi network connection	20
4. CLEANING	21
4.1 Manual cooking chamber cleaning	21
4.2 Semi-automatic cooking chamber cleaning	22
4.3 Cleaning the fans	22
4.4 Cleaning the door gasket	22
4.5 Cleaning the door	22
4.6 Cleaning the external casing	22
4.7 Inactivity period	22
5. MAINTENANCE INSTRUCTIONS	23
5.1 Access to the components for inspection	23
5.2 Safety thermal devices	23
5.3 Replacing the cooking chamber gasket	23
6. TROUBLESHOOTING	24
7. POSSIBLE ALARMS	24
7. TECHNICAL SUPPORT	25
8. DISPOSAL OF THE APPLIANCE	25
9. CONVENTIONAL WARRANTY	25
10. AVAILABILITY AND SUPPLY OF SPARE PARTS	26
11. APPLICABLE LAW AND COMPETENT COURT	26

GENERAL INFORMATION

It is essential for this instruction manual to be stored together with the appliance for future referencing; in the event of misplacing it, a copy must be obtained directly from the manufacturer. This information has been prepared for your safety and that of others.

Therefore, we kindly ask you to read it carefully before installing and using the appliance.

If upon reception of the goods the packaging should not be intact or should it be damaged, affix the following wording: "GOODS SUBJECT TO CHECK", with the specification of the damage and countersigned by the driver; file a written complaint with the vendor within 4 calendar days (not business days) from the date of delivery, after which no complaints shall be accepted.

For periodic maintenance checks and repairs, contact your nearest Technical Support Centre and only use original spare parts. Failure to comply with this provision shall forfeit the warranty right

The "technical data" plate is located on the side panel of the appliance.

A periodic check (at least once a year) of the appliance contributes to extending its service life and assures proper operation.

Any maintenance operation on the appliance must only be done by highly qualified personnel trained in the operations to be performed.

Before performing any maintenance on the appliance, the power supply must be disconnected (act on the safety magnetic circuit breaker located upstream of the appliance) and let it cool down.

The components that might require maintenance are all accessible by removing the left side and back of the appliance.

The inappropriate or incorrect use of the appliance shall invalidate any liability and warranty right by the Manufacturer.



BURN and INJURY HAZARD

- The temperature of the appliance's external surfaces may exceed 60°C, only touch control elements. Burn hazard!
- Pay attention to handling food containers during and after cooking: they might be very hot. Wear appropriate protective thermal clothing to prevent burns.
- During operation, with the door open, do not remove the fan cover; do not touch the moving fans and resistors which are still hot.
- **The maximum working height, referred to the highest surface level, must be 160 centimetres from the**

floor. After installing the appliance apply the suitable adhesive symbol  (supplied) at a height of 160 centimetres.

- To prevent boiling, do not use containers filled with liquids or food that liquefy with heat, in excessive amounts that cannot be easily kept under control. For this reason, only use trays that let you see inside the container. When extracting a tray containing hot liquid pay attention not to spill any liquid.



ELECTRIC SHOCK HAZARD

- Before performing any cleaning on the appliance, disconnect the power supply (from the safety circuit breaker) and water supply (close the water cock). Let it cool completely.

- Any modification to the electrical system that might be required to install the appliance must be carried out by competent personnel only.
- The power supply system must be fitted with an effective earthing connection according to the regulations in force.
- In the permanent connection to the mains, a protective pole switch must be installed between the appliance and the mains with minimum opening between the contacts of overvoltage category III (4000V), sized for the load and complying with applicable regulations (automatic circuit breaker).
- If the power supply cable is damaged, it must be replaced by the manufacturer or their technical support service, or in any case by a person with similar qualifications, to prevent any risk.
- The appliance also has electrical components inside, for safety reasons it is forbidden to wash it with water or steam jets especially if aimed at the aeration vents on the metal surfaces of its outer casing.



FIRE HAZARD

- No foods containing easily flammable substances must be cooked, such as alcohol-based foods; self-combustion phenomena might occur leading to fires and explosions in the cooking chamber.
- Before using the appliance, make sure that there are no non-compliant objects (e.g. User manuals, plastic bags or other flammable objects) or detergent residues, inside the cooking chamber.
- Always keep the cooking chamber clean. Cooking liquids (fats) or food residues may ignite!

USER SAFETY

- The appliance is intended for professional use in institutional and professional kitchens and must only be used by skilled personnel who have been trained on its proper use. For safety reasons the appliance must be supervised during operation.
- The appliance is not intended to be used by children and/or persons with impaired physical, sensory or mental abilities, or who lack experience or knowledge, unless they are supervised by a person responsible for their safety, or who has been instructed on using the appliance.
- In the event of failure or poor operation, switch off the appliance, close the water supply cock, disconnect the power supply and contact an authorised Technical Support Centre.
- This appliance shall be used only for the purposes for which it was designed, meaning for all types of baking of pastries, baked goods and food: fresh and frozen; for reconditioning chilled and frozen food, for steam cooking meats, fish and vegetables. Any other use is considered improper.
- The noise level of the appliance in operation is less than 70 dB (A).

INFORMATION FOR THE USER

- When the appliance is used for the first time it is recommended to run an empty cycle for 40/50 minutes at a temperature of 220/230°C. In this way all unpleasant yet fully normal smells due to heating the thermal insulation enveloping the cooking chamber and the silicone used for its external sealing are dissipated.
- Avoid prolonged permanence on the steel surfaces of foods containing acidic substances (lemon juice, vinegar, salt, etc.) which cause corrosive deterioration.
- The appliance must be cleaned regularly, even daily, to ensure the best functionality and to extend its service life.
- If specific detergents (degreasers) are used for cleaning stainless steel, ensure they do not contain corrosive acid substances (no presence of chlorine even if diluted) or abrasive substances. Carefully follow the instructions and warnings of the detergent's manufacturer and take precautions such as using adequate rubber gloves.
- Strictly avoid using scouring pads, steel wool and scrapers that may ruin the treated surfaces.

COOKING TIPS

- In placing the food in the cooking chamber, maintain a space of at least 40 mm between trays in order not to excessively obstruct air circulation.

- Do not use trays with sides higher than necessary: the sides form barriers that prevent hot air circulation.
- Preheat the oven every time before cooking to achieve top performance.
- For cooking as consistently as possible, spread the food evenly in every tray taking into account its size, layer or thickness.
- Avoid adding salt to food in the cooking chamber.
- To check correct progress of the cooking cycle use the chamber's internal lighting: avoid uselessly opening the door, which causes wastes of energy and longer cooking times.

RESIDUAL RISKS

- After baking open the door with caution, to avoid the violent outflow of heat which might cause burns.
- During oven operation pay attention to hot areas of its outer surfaces (marked on the appliance).
- Do not use the door handle to move the appliance (possible glass breakage).
- The supporting bench must be able to withstand the weight of the machine and house it correctly.
- The appliance is fitted with electrical parts and must never be washed with a water or steam jet.
- The appliance is electrically connected: disconnect the power supply before performing any type of cleaning.
- To avoid incorrect connections of the appliance, the relevant electrical/water connections are marked on the appliance by suitable identification plates.

1. TECHNICAL SERVICE

- It is essential for this instruction manual to be stored together with the appliance for future referencing; in the event of misplacing it, a copy must be obtained directly from the manufacturer.
- This information has been prepared for your safety and that of others; therefore we kindly ask you to read it carefully before installing and using the appliance.
- For periodic maintenance checks and repairs, contact your nearest Technical Support Centre and only use original spare parts. Failure to comply with this provision shall forfeit the warranty right.
- All installation and commissioning operations must exclusively be performed by technically skilled installers, in compliance with the instructions of the Manufacturer and in compliance with national standards in force.
- The "technical data" plate is located on the side panel of the appliance.

Note: The inappropriate or incorrect use of the appliance and failure to comply with installation rules shall invalidate any liability by the Manufacturer.

2. INSTRUCTIONS FOR THE INSTALLER

The following instructions are intended for skilled installers, to perform installation, electrical and water connection operations in the most correct manner and according to the safety regulations in force in the country of installation of the appliance.

The Manufacturing Company shall not be liable for damage or harm to persons, pets or property arising from installation errors. Nor are they responsible for any appliance breakage caused by faulty installation.

2.1 Storage

If the appliance is stored in a warehouse, the ambient temperature must never drop below 0°C. Before switching on the appliance it must be brought to a temperature of at least +10°C.

2.2 Transportation of the appliance

During transportation the appliance must be left in its packaging in order to protect it from any external damage.

The weight of the appliance must also be taken into account in order to prevent overturning.

2.3 Unpacking the appliance

Remove the packaging before installation. It consists of a wooden pallet supporting the appliance and a cardboard casing protecting it. Ensure the appliance has not undergone any damage during transport; otherwise immediately alert your dealer and/or carrier.

2.4 Removal of the protective film

Before using the appliance accurately remove the special film protecting the stainless steel components, avoiding glue residues on the surfaces; if required, immediately remove them using an appropriate non flammable solvent. Do not use any tools that might scratch the surfaces or any acid-based or abrasive detergents.

2.5 Protective film/package disposal

TECNOEKA has been committed for years to increasing the environmental compatibility of its equipment, with continuous efforts to reduce energy consumption and waste. TECNOEKA intends to protect the environment and recommends to dispose of all different types of material, in the appropriate separate collection containers.

The protective film and packaging must be disposed of in strict compliance with the regulations in force in the country of installation of the appliance. **The various materials** (wood-paper-carton-nylon-metal tacks) that may comprise the packaging are potentially dangerous and must be kept out of reach of children and animals; **they must be duly separated and delivered to the respective collection centres** (recycling centres). In any case please adhere to the local environmental protection regulations.

2.6 Placement

Check the place of installation making sure that the transit areas (any doors and corridors) are sufficiently wide and the floor supports the appliance's weight (the appliance's weight and dimensions with/without pallets are provided in the attached "Technical Data Sheet"). The appliance must be transported with mechanical means (e.g. pallet jack). The installation rooms must be well-ventilated with permanent aeration vents; must be equipped with the proper electrical and hydro systems, built in accordance with the standards related to facilities and workplace safety in the country of installation.

The maximum working height, referring to the highest surface level, must be 1.6 metres from the floor.

After installing the appliance, if required, apply the suitable adhesive symbol  (supplied) at a height of 1.6 metres. To favour air circulation around the appliance, leave a space of about 10 cm between the appliance sides and the surrounding walls (or other appliance), and between the back and the back wall (see the attached "Technical Data Sheet"). The appliance must be positioned so that the rear wall is easily accessible to set up various electrical connections and to carry out any possible maintenance. Do not install the appliance near any equipment that may reach high temperature values (e.g. deep fryers).

Should the appliance be installed near walls, shelves, counters and the like, these must be non-flammable or heat-resistant; otherwise, they must be protected by adequate fire retardant coating. Accordingly, it is indispensable to act in compliance with the fire prevention regulations in force.

Cooking produces hot smoke/vapour and odours which are extracted through the suitable vent device

located at the top of the appliance and marked with the symbol . It is recommended to place the appliance under an extraction hood or to use the suitable **TECNOEKA. condensation hoods** in order to convey the smoke/vapour to the outside.

Warnings

Make sure there are no objects and/or materials obstructing the oven's exhaust device.

The hot smoke/vapour produced during cooking must run freely out of the exhaust device in order not to compromise the regular operation of the oven.

Inflammable materials must not be left near the oven's exhaust device.

2.6.1 Table top oven placement

The appliance must be placed in a perfectly horizontal position on a table or similar support; **never on the floor**. To facilitate oven levelling, the feet are adjustable in height.

For safety reasons it is recommended to use the specific table produced by **TECNOEKA**; otherwise the dimensions and weight of the appliance must be taken into account.

The appliance is unsuitable for recessed installation and cannot work without the 4 supporting feet.

Warning

If the appliance is positioned on a wheeled table/support, ensure that the intended movement does not damage electrical wires, water pipes, drain pipes or anything else.

2.7 Electrical connection

The appliance's connection to the electric power network and the connection systems must comply with the applicable regulations in the country of installation. Before setting up the electrical connection ensure that:

the voltage and frequency of the power supply system match the specifications of the "technical data" plate affixed to the side of the appliance;

the power supply system is able to withstand the appliance's load (see "technical data" plate);

the power supply system is fitted with an effective earthing connection according to the regulations in force;

in the permanent connection to the electric power network, a protective pole switch must be placed between the appliance and the mains (e.g. circuit breaker) with minimum opening between the contacts of overvoltage category III (4000V) and a differential switch, sized for the load and complying with applicable regulations.

the protective pole switch used for the connection is easily accessible when the appliance is installed;

the yellow/green earthing cable is not interrupted by the switch;

when the appliance is running, the power supply voltage does not deviate from the rated voltage value by $\pm 10\%$.

Ensure that the power supply cable does not come into contact with the appliance's hot parts.

If the power supply cable is damaged, it must be replaced by the manufacturer or their technical support service, or in any case by a person with similar qualifications, to prevent any risk.

The appliance must be connected to an equipotential system the effectiveness of which must be suitably assessed according to applicable regulations. This connection must be set up between appliances through the suitable terminal which is marked with the symbol . The equipotential conductor must have a minimum section of 2.5mm².

The equipotential terminal is on the back of the appliance (see the attached "Technical Data Sheet").

2.8 Power supply cable connection (replacement)

The appliance is fitted with a power supply cable connected to the internal terminal board; if it needs to be replaced with a longer one or because it is damaged, it can only be done with another cable having the same electrical characteristics (insulation type/number of conductors/size of conductors in mm²).

Remove the back and/or the right side of the appliance to access the power supply terminal board. Loosen the cable retainer located on the rear (at the bottom) of the appliance (see the attached "Technical Data Sheet"). Disconnect the power supply cable from the terminal board and remove it from the relative cable gland. Insert the new power supply cable in the cable gland up to the terminal board. Prepare the conductors for the connection with the terminal board so that the earth conductor is the last to be extracted from its terminal should the cable be accidentally pulled.

The cable connection must be **type "Y"** and the insulation of the cable sheath must match type **H07RN-F**.

The correct section of the cable is shown on the diagram of the power supply terminal board, according to the type of connection between appliance and mains (The cable must match the features in the attached "Technical Data Sheet").

When connected, tighten the cable retainer on the back of the appliance and reassemble the left side and/or the back.

230V ~

Connect the conductor of **phase (L)** of the cable to the terminals of the terminal board marked with **"1"**, **"2"** and **"3"** (**brown conductor**) and the **neutral (N)** conductor to the terminals marked with **"4"** and **"5"** (**blue conductor**); the **earth conductor (yellow/green)** must be connected to the terminal marked with the symbol  (see diagram available by the terminal board).

2.9 Connection to the water mains

The appliance must be supplied with drinking water at a maximum temperature of 30°C. The water pressure must be between 100 and 200 kPa (1.0 -2.0 bar). If the mains pressure exceeds 2.0 bar, install a pressure reducer upstream of the appliance. If the value is lower than 1.0 bar use a pump to raise the pressure.

2.9.1 Water inlet for humidification / steam

The appliance is equipped with a standardised flexible hose (1.5 metres) with threaded 3/4" female fittings and relative gaskets (Fig. 1). Old joints must not be re-used.

The appliance must be supplied with **softened drinking water** with hardness between 0.5°f and 3°f. It is **obligatory to use a softener** to reduce the formation of limescale inside the cooking chamber. **THE MANUFACTURING COMPANY DISCLAIMS ANY LIABILITY FOR DIRECT OR INDIRECT DAMAGE CAUSED TO THE HOOD DUE TO FAILURE TO COMPLY WITH THIS DIRECTIVE.**

The connection to the water mains must be set up through the 3/4" threaded solenoid valve located on the back (at the bottom) of the appliance (see the attached "Technical Data Sheet"), using the supplied flexible hose, with a mechanical filter and stopcock installed in between (before connecting the filter, drain off a certain amount of water to flush any dirt out of the hose).

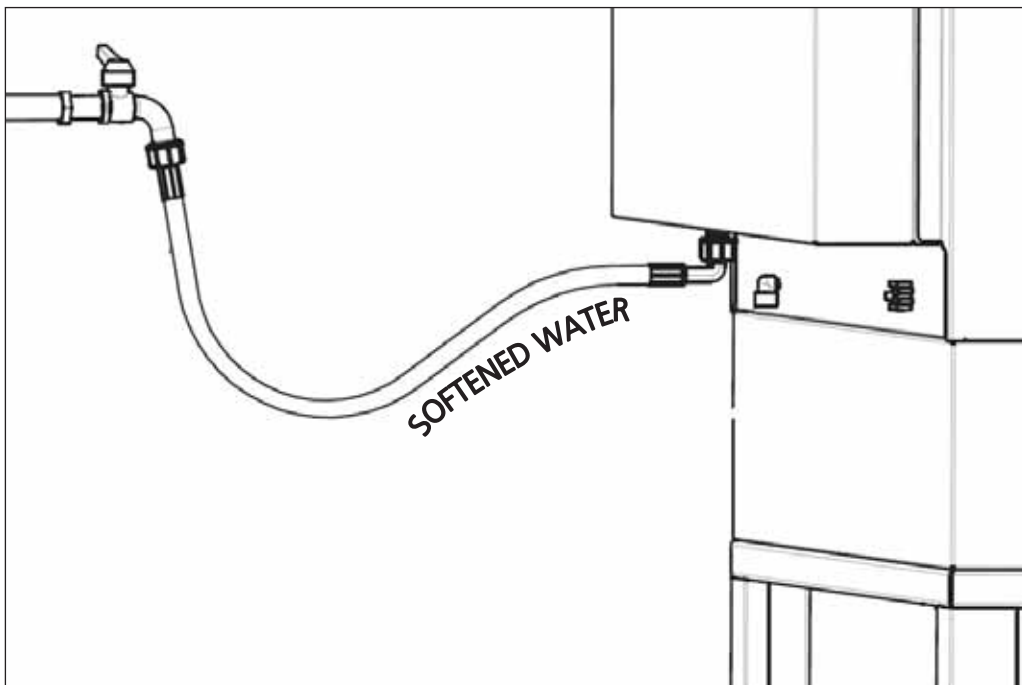

Fig.1

Warning

Any damage caused by limescale or other chemicals contained in the water are not covered by warranty.

2.10 Water drain

A drain pipe comes out of the rear of the appliance (see the attached "Technical Data Sheet") to drain the cooking chamber. This pipe must be connected to piping with 30 mm internal diameter (DN 16) resistant to steam temperatures (90°C-100°C): avoid metal ones.

The piping must be rigid and must not have bottlenecks along the discharge path (it is advisable to use commercial pipes of special plastic material, with an internal "sealing" O-RING, and to limit the use of "elbow" bends).

The piping must also maintain a steady slope (min. 4-5%) along its entire length.

The considered length is that of the drain pipe of the appliance to the discharge point and must not exceed the measurement of 1.5 meters.

It is mandatory to connect the appliance's drain to the grey water network **through an adequate trap**, in order to stop steam/odours from coming out of the drain. The connection to the drain water must be set up separately for each appliance; with multiple appliances connected to the same drain pipe, ensure that the pipe is suitably sized to assure regular drainage with no hindrances.

2.10.1 Water drain for tabletop ovens

The exhaust pipe can be conveyed to an open (grilled) floor drain (Fig.4); otherwise, between the drain pipe of the appliance and the drain point with a "collection cup" (Fig. 5), there must be a height difference of at least 30 cm in order to facilitate regular flow of water. In any case, the "air gap" (distance between the drain pipe from the appliance and the open drain or the "collection vessel" of the drain duct pipe) must be at least 25 mm.

Wall-mounted discharge is also allowed as long as the drain pipe maintains the steady slope of 4-5%.

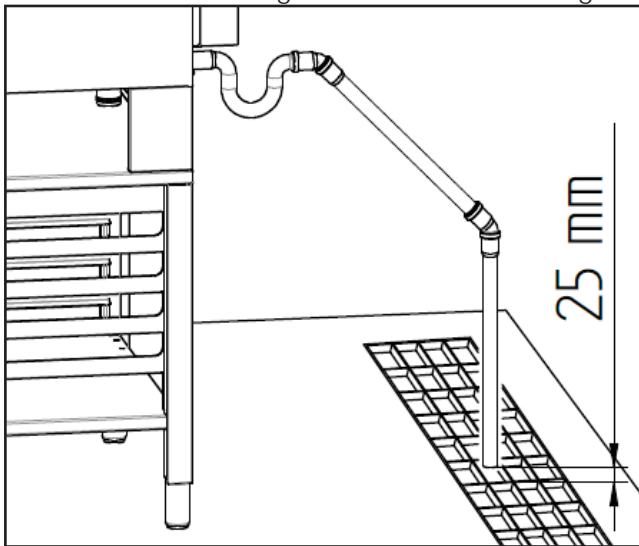

Fig. 4

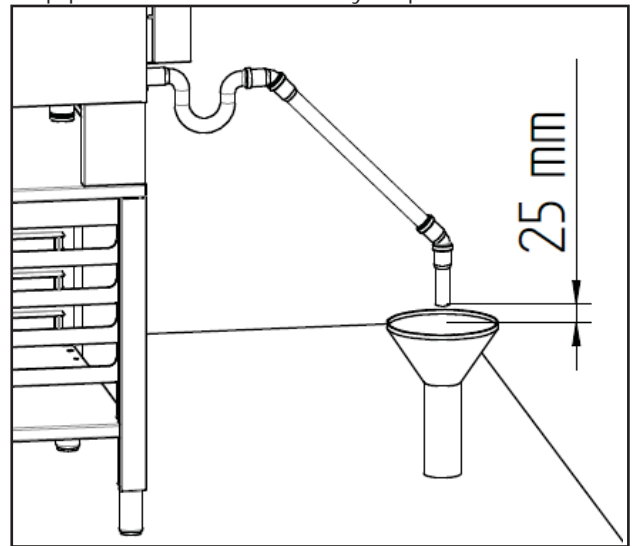

Fig. 5

2.11 Steam drain

The appliance is equipped with a special metal pipe (DN30) for the discharge of steam from the cooking chamber.

No other type of pipe can be connected to this pipe, which protrudes from the back of the casing.

Failure to comply with this specific prohibition shall relieve the Manufacturer from any liability concerning the potential malfunction of the appliance and poor cooking quality.

Increasing the length of the original drain hose may result in the formation of abnormal "condensation" in the cooking chamber.

To prevent steam from escaping from the exhaust pipe, place the appliance under the extractor hood, or connect it to the "TECNOEKA" extractor hood/condensing hood, specific for the appliance model used.

3. USER INSTRUCTIONS

3.1 Ignition

The oven has an "ON/OFF" key to electrically power the electronic control board and to activate its operating functionality (Fig. 1).

The key (A) is not directly visible as it is located under the oven base; an identification plate (B) indicates its presence.

To activate the oven function, set the key to "ON".

For the first 10 seconds, the display shows the "computer codes" of the electronics that manage the oven, then the "Date and Time", the "EKA" logo and the symbol are highlighted .

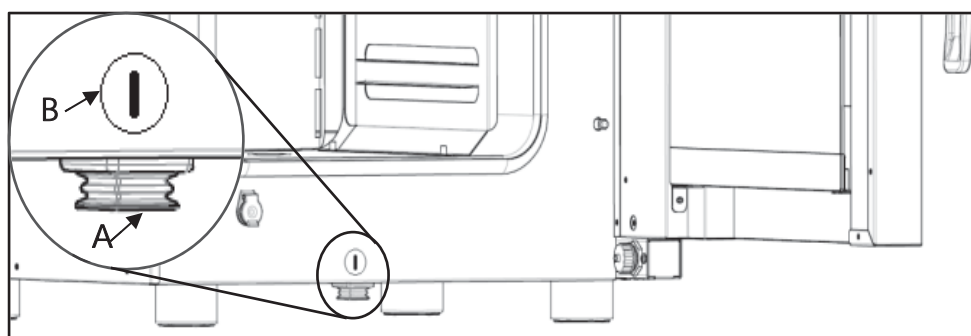



Fig. 1

3.2 Touch Screen Control Operation











The Touch Screen command works by touching, with a finger on the display, the icon of the parameter and/or function displayed (use only clean dry fingers, and not other tools such as knives, forks or other objects in general).

“Stand-by” Mode



If the oven is not being used (it is not performing any operation), after 10 minutes the “stand-by” mode is automatically activated. In this configuration, the current time is visible in the centre of the display. To reactivate the oven’s functional mode, simply touch the symbol .

To activate the “stand-by” mode, manually touch the symbol  from the “HOME” screen.

Explanations of symbols:

	CONFIRM START		ON (ACTIVE)
	STOP		OFF (NOT ACTIVE)
	BACK		INCREASE VALUE
	HOME		DECREASE VALUE
	ADDITIONAL FUNCTIONS		PREHEATING or DELAYED START COMPLETED

3.3 COOKING PARAMETERS SCREEN

Touching the symbol  from the “STAND-BY” screen (Fig.2), or the symbol  from the “HOME” screen (Fig.3), displays the “COOKING PARAMETERS” screen (Fig.4), where it is possible to set the following parameters:

- Preheating
- Delayed start
- Enabling of cooking with “core probe”
- Save recipe
- Cooking phases (from 1 to 5)
- Cooking time / “Core probe” temperature
- Cooking temperature
- Humidity %
- Fan speed



Fig.2

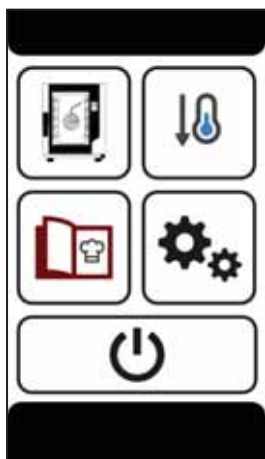

Fig.3

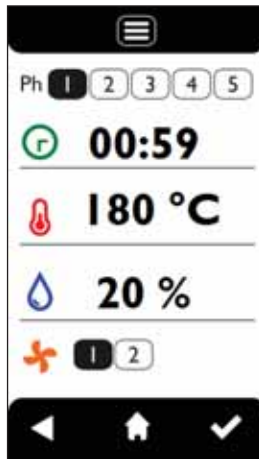









Fig.4

Operating parameters

	COOKING TIME	from 1 minute to 11 hours and 59 minutes or "INFINITE" time (∞)
	COOKING TEMPERATURE	from 30°C to 270°C (from 86°F to 518°F)
	CORE TEMPERATURE	from 01°C to 99°C (from 33°F to 210°F)
	HUMIDITY	from off to 100% with 10% step
	FAN SPEED	from 1 to 2

3.3 PREHEATING SETTING

From the "COOKING PARAMETERS" screen (Fig.3), when "phase 1" is selected, touching the symbol  displays the "ADDITIONAL FUNCTIONS" screen (Fig.4). By touching the value of the symbol,  it is possible to set the temperature increase with respect to the temperature set in "phase 1" using the keyboard that appears (Fig.5); touch the symbol  to confirm.

The PREHEATING function must not exceed 270°C.

To deactivate the PREHEATING function, the value 0°C must be set.

For example, if a cooking temperature of 180°C ("phase 1") and a PREHEATING temperature of 50°C is set, a temperature value of 230°C will be reached inside the cooking chamber.

During the preheating phase, the "PREHEATING IN PROGRESS" screen (Fig.6) appears, which displays the actual temperature and the preheating temperature set.

An acoustic signal ("beep") and the symbol  warns that this temperature has been reached, which is maintained while the oven door is closed.

Open the door (the beeping stops) and introduce the product to be cooked. Close the door: the cooking cycle starts automatically.

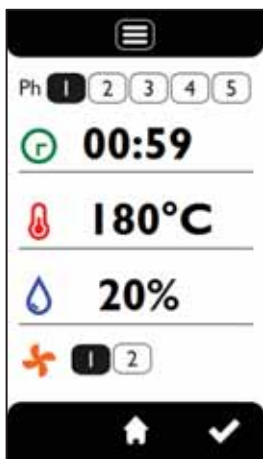

Fig.3

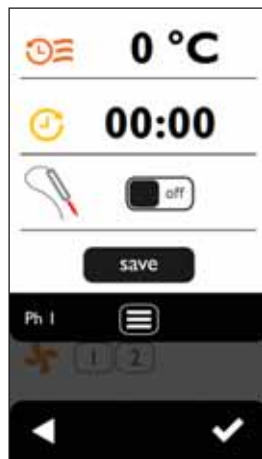

Fig.4





Fig.5



Fig.6

3.4 SETTING THE COOKING TIME

From the "COOKING PARAMETERS" screen (Fig.7) by touching the value of the symbol  it is possible to set the desired value (hours and minutes) using the keyboard that appears (Fig.8). To set infinite time select the symbol  and touch the symbol  to confirm.

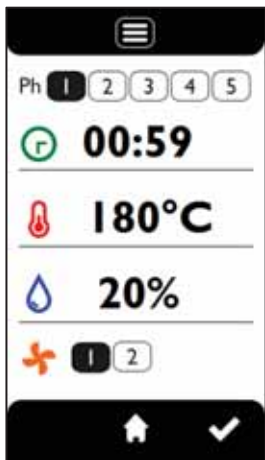





Fig.7



Fig.8



3.4 SETTING THE COOKING PHASES

Each cooking cycle can include up to a maximum of 5 PHASES (steps). For each phase, it is possible to set the operating parameters and their desired values.

After setting the parameters and their values for the **first phase** ("Ph 1"), the subsequent ones ("Ph 2", "Ph 3" ...), can be set by touching the symbols    .

For each phase, the values of the desired operating parameters must be set.

3.5 SETTING OF COOKING TEMPERATURE

From the "COOKING PARAMETERS" screen (Fig.9) by touching the value of the symbol  it is possible to set the desired value using the keyboard that appears (Fig.10); touch the symbol  to confirm.

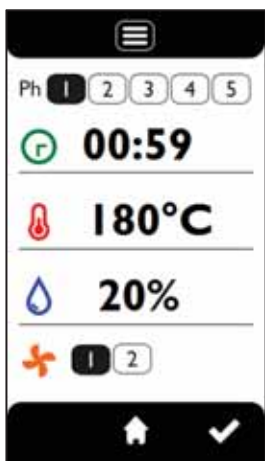







Fig.9



Fig.10

3.6 SETTING THE CORE TEMPERATURE

From the "COOKING PARAMETERS" screen (Fig.11), touching the symbol  displays the "ADDITIONAL FUNCTIONS" screen (Fig.12). Touching the "switch" () activates the "CORE PROBE" function (); touch the symbol  to confirm. The "CORE PROBE COOKING PARAMETERS" screen (Fig.13) appears. Touching the value of the symbol  it is possible to set the desired value using the keyboard that appears (Fig.14).

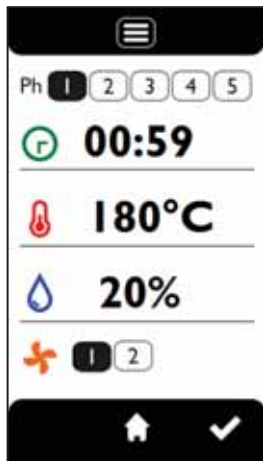

Fig.11



Fig.12

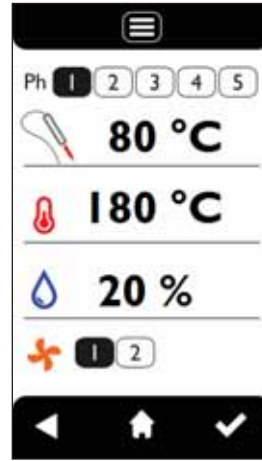

Fig.13



Fig.14



INSIGHTS:

• COOKING WITH CORE PROBE

There are two parameters to be set to cook with core probe: **core temperature** and **cooking temperature**. The cooking time is no longer a control parameter and so does not appear on the "summary screen".

If the cooking cycle consists of a single step, the oven works until the temperature detected by the core probe is reached inside the food. If the cooking cycle consists of several steps and core probe cooking is enabled in one of them, once the temperature detected by the core probe is reached, the oven continues to work switching to the next step.

If, during a cooking cycle with needle shaped thermal probe (core probe) the probe is not properly connected, the display shows an error with corresponding sound alarm.

IMPORTANT

The needle shaped thermal probe must be inserted inside the food, in the thickest area, avoiding contact with any bones.

If a cooking cycle with core probe is enabled, the needle shaped thermal probe must already be connected to the specific socket on the bottom of the oven; otherwise, the display will show the corresponding alarm.

With the door closed, the needle shaped thermal probe cable must pass between the door gasket (bottom area) and the door itself.

Warning

The pin of the probe must be inserted in the appropriate seat, making sure that the "socket" zone A of the probe is positioned as in Fig. 15 such that it does not interfere with the metallic structure of the door when it is closed.

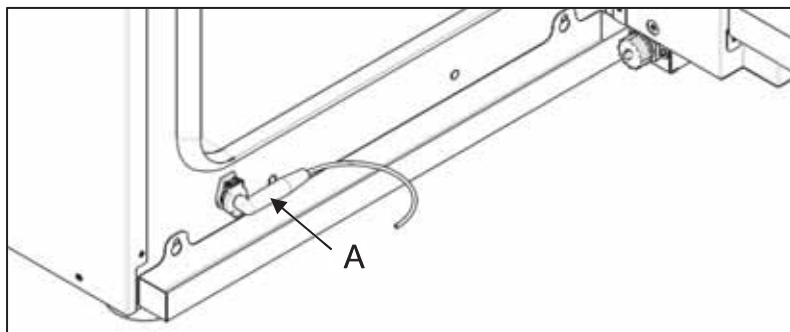







Fig.15



3.7 HUMIDITY SETTING

From the "COOKING PARAMETERS" screen, by touching the value of the symbol , it is possible to set the desired value using the symbols  and . Touch the symbol  to confirm.

3.8 FAN SPEED SETTING

From the "COOKING PARAMETERS" screen (Fig.2) by touching the symbols   it is possible to select the fan speed. The selected symbol is highlighted.

3.8 DELAYED START SETTING

From the "COOKING PARAMETERS" screen (Fig.16), when "phase 1" is selected, touching the symbol  displays the "ADDITIONAL FUNCTIONS" screen (Fig.17). By touching the value of the symbol  it is possible to set the desired value using the keyboard that appears (Fig.18). Touch the symbol  to confirm.

The DELAYED START can be set for a maximum time of **23 hours and 59 minutes**.

To deactivate the DELAYED START function, the value 00:00 must be set.

During the delayed start phase, the "DELAYED START IN PROGRESS" screen appears (Fig.19) which displays the "count-down" of the time before the start of the cooking cycle.

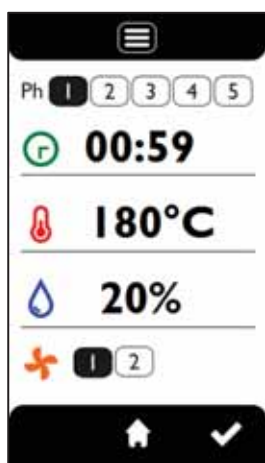

Fig.16

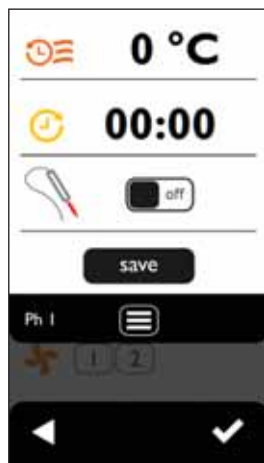

Fig.17





Fig.18



Fig.19

3.9 STARTING/STOPPING THE COOKING CYCLE

After setting the parameters and their desired values for cooking, to start the cycle, simply touch the symbol .

To interrupt the cooking cycle at any time, touch any area of the screen to return to the parameters screen and keep the symbol pressed for 3 seconds .

When a cooking cycle ends (in "manual" mode or in "programmed" mode) an acoustic warning ("beep") is activated for 1 minute.

When cooking is active, the "COOKING" screen appears (Fig.20) or, if the core probe is present, the "CORE PROBE COOKING" screen appears (Fig.21).

This screen displays:

1. Number of the phase in progress and number of total phases
2. remaining time of the current phase or actual core probe temperature
3. remaining cooking time or set core probe temperature
4. actual temperature in the cooking chamber
5. set temperature
6. set humidity percentage
7. selected fan speed

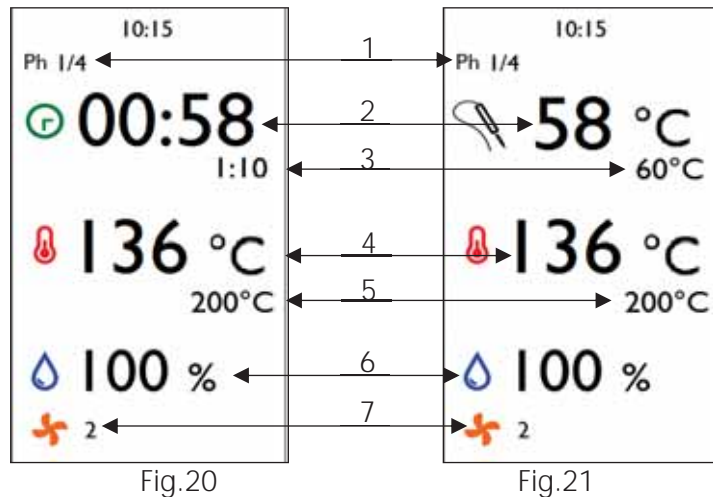

The parameter values can also be changed with the cooking cycle active. By touching any area of the screen the parameter screen reappears; by touching the symbol ◀ the "COOKING"/"CORE PROBE COOKING" screen reappears.

3.10 Recipe book

The oven has a recipe book in which up to **100 recipes** can be stored (60 user and 40 Cloud). To access the recipe book, touch the symbol 📖 on the "HOME" screen (Fig.22); the "RECIPE BOOK" screen appears (Fig.23) which displays the empty recipes in light colour and the recipes in dark colour. Selecting the recipe number, a red box appears (Fig.24). To start the cooking cycle touch the symbol ✓ ..

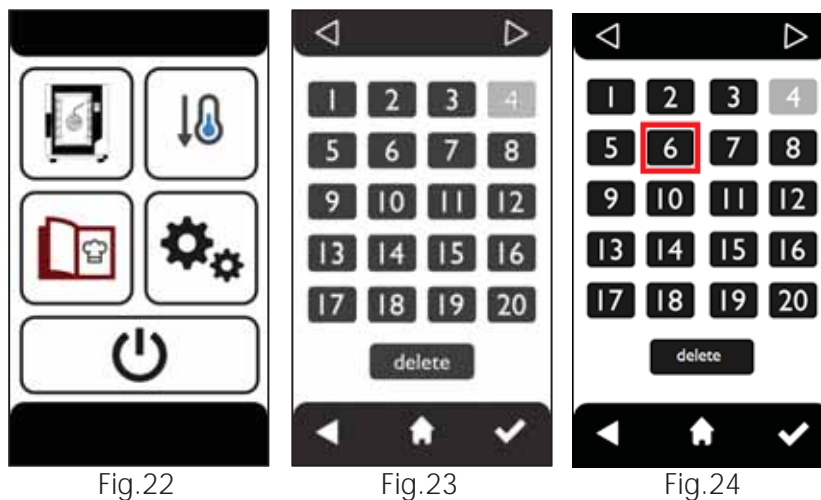

3.11 Saving the new recipe

Set the desired cooking cycle parameter values in the "COOKING PARAMETERS" screen for the new recipe to be saved. Touch the symbol  and the "ADDITIONAL FUNCTIONS" screen appears (Fig.25). Touch the "save" key and the "RECIPE BOOK" screen appears, which displays the empty recipes in light colour and the recipes present in dark colour. Selecting the recipe number a red box appears. It is also possible to select a recipe already present (dark colour). In this case it will be overwritten. To save the recipe touch the "save" button (Fig.26).

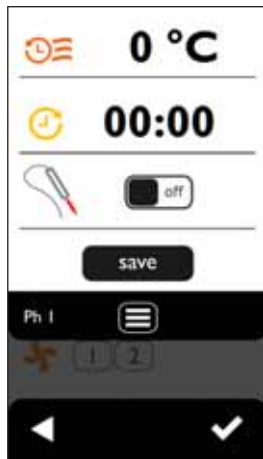



Fig.25



Fig. 26



3.12 Deleting a recipe

Tap the symbol  on the "HOME" screen; the "RECIPE BOOK" screen appears, displaying empty recipes in light colour and recipes in dark colour. Selecting the recipe number a red box appears. To delete the selected recipe touch the "delete" key (Fig.24).

3.13 Import/Export" with USB stick

Through the "USB socket" in the lower hinge of the door, it is possible to "Import" new recipes into the recipe book, or "Export" from the same recipe book the recipes stored in it, making use of "USB stick".



3.13.1 "Exporting" recipes (saved programs)

After connecting the "USB stick" ("empty") to the relative "USB socket", from the "HOME" screen (Fig.27) touch the symbol . The "SETTINGS" screen appears (Fig.28). Touch the symbol . Touch the "export" button (Fig.29). An acoustic warning ("beep") will be heard as confirmation.

Important

If the "USB stick" is not connected or detected, error E04 appears.

3.13.2 "Importing" recipes (saved programs)

After connecting the "USB stick" ("empty") to the relative "USB socket", from the "HOME" screen (Fig.27) touch the symbol . The "SETTINGS" screen appears (Fig.28). Touch the symbol . Touch the "import" button (Fig.29). An acoustic warning ("beep") will be heard as confirmation.

Important

If the "USB stick" is not connected or detected, error E04 appears.

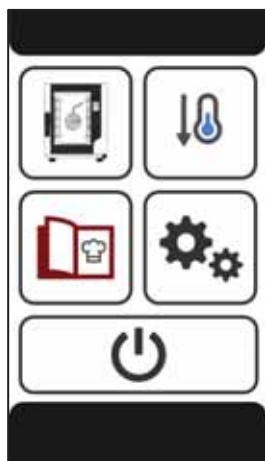

Fig.27



Fig.28



Fig.29

3.14 Cooling

To activate the function, touch the symbol  on the "HOME" screen (Fig.30). The "COOLING" screen (Fig.31) appears, which displays the real-time temperature inside the cooking chamber. Open the oven door to activate the function.

The function can be deactivated by touching the symbol  otherwise, it is automatically deactivated when the temperature inside the cooking chamber falls to 40°C.



Fig.30

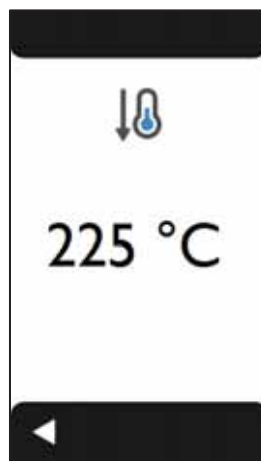

Fig.31

Warning

When operating with the door open, do not remove the fan cover casing; do not touch the moving fans and the heating elements that are still hot.

3.15 Settings menu

From the "HOME" screen (Fig.32) touch the symbol . The "SETTINGS" screen appears (Fig.33). The available functions are:

- Date and time
- Information menu
- Import/Export
- Unit of Measurement
- Screen theme
- HACCP

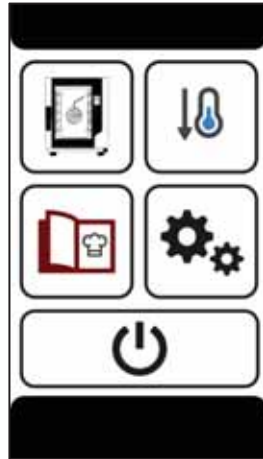

Fig.32



Fig.33

3.15.1 Date and Time





From the "SETTINGS" screen (Fig.34) touch the symbol . The "DATE and TIME" screen appears (Fig.35). By touching the single digits these will start to flash. By touching the symbols  and  set the desired value. Touch the symbol  to confirm, or the symbol  to exit without saving.



Fig.34

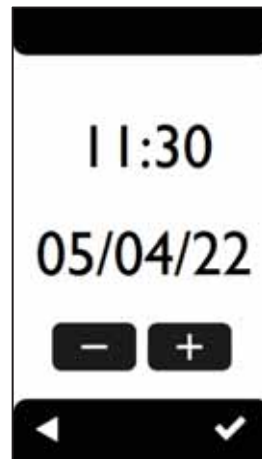

Fig.35

3.15.2 Units of measurement

From the "SETTINGS" screen (Fig.36) touch the symbol $\frac{^{\circ}\text{F}}{^{\circ}\text{C}}$. The "MEASUREMENT UNIT" screen (Fig.37) appears. Touching the "switch" changes the temperature measurement unit:

off → Celsius (°C)

on → Fahrenheit (°F)

Tap the symbol ◀ to confirm and return to the previous screen.



Fig.34



Fig.35

3.15.3 Information menu

From the "SETTINGS" screen, touch the symbol i . The "INFO MENU" screen appears. Type in the password "1234". Touch the symbol ✓ to confirm. The screen containing the information of the FW version of the display, FW version of the power board and the calibration set appears. After 10" the "SETTINGS" screen appears again.

3.15.4 Screen theme

From the "SETTINGS" screen (Fig.36) touch the symbol ☾ . The "THEME" screen appears (Fig.37) from where it is possible to select the theme of the screens:

B → black screens (dark theme)

W → white screens (light theme)

Tap the symbol ◀ to confirm and return to the previous screen.



Fig.36

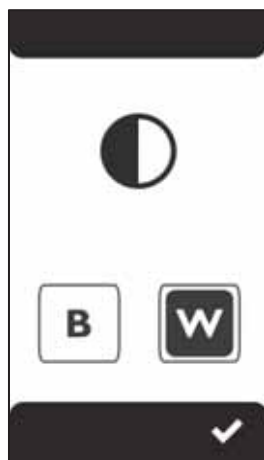

Fig.37



3.15.5 Import/Export

It is possible to import ("upload") and export ("download") the cooking programs (recipes) via "USB stick" (see paragraph [3.13 Import/Export" with USB stick](#)).

3.15.6 "HACCP" function

The purpose of the HACCP function is to record the operational data of the cooking performed, constantly monitoring its performance.

The HACCP data is recorded on a "USB stick" that must be connected to the appropriate "USB socket" of the oven.

After connecting the "USB stick" in the appropriate "USB socket" of the oven from the "SETTINGS" screen (Fig.38) touch the symbol . The "HACCP" screen (Fig.39) appears. By touching the "switch" () the function  is activated; the operating parameters of the cooking cycle (manual or programmed) are recorded in a "file" inside the "USB stick".

Important

If the "USB stick" is not connected or detected, error E04 appears.



Fig.38



Fig.39

3.15.7 Display (on PC) of HACCP data

To display the operating parameters of a finished cooking cycle on the PC, simply remove the "USB stick" from the "USB socket" of the oven and insert it into the "USB socket" of the PC.

The HACCP "files" inside the "USB stick" can be "opened" and displayed with the same procedure used for any "file".

If multiple cooking events are performed, but on different days, they are recorded in different HACCP "files": identified by the date of the day on which the cooking events took place.

3.16 Wi-Fi network connection

It is possible to connect the oven to a Wi-Fi network to use the "EkaCloud" service (paid service).

The oven generates a Wi-Fi network called TECNOEKA_XXXX, where XXXX represents the last 4 digits of the oven serial number.

Using any device (PC-Tablet-SmartPhone), perform these operations:

- connect to the Wi-Fi network generated by the oven (Fig.40).
- enter the password that is identical to the network name (case-sensitive).
- Using a browser, connect to the following address <http://192.168.4.1/> or scan the QR code
- The screen appears where the information of the "Device" oven (serial-model-firmware) and the status of the "Status" connection are present. Select "Wifi" in the top right (Fig.41).



- The “ Wi-Fi Configuration” screen appears (Fig.42). Using the drop-down menu, select the name of the Internet connection to connect to (Fig.43).
- Enter the password.
- Select “ Save” to confirm the connection.
- **Do not change the “ Cloud Configuration” settings**
- Wait for the word “ Writing” and select “ Status” in the top right.
- The “ Status” screen must display “ WiFi: **Connected**” (Fig.44)

If the connection is successful, the oven display shows the symbol  in the top right.



Fig.40



Fig.41



Fig.42



Fig.43



Fig.44

4. CLEANING

4.1 Manual cooking chamber cleaning

For hygienic reasons it is good practice to clean the cooking chamber on a daily basis, at the end of every day the oven is used. Correct cleaning also prevents the formation of corrosive phenomena inside the chamber, as well as preventing the danger of accidental combustion due to any grease and food residues accumulated over time.

To aid cleaning remove the side grilles. The cleaning detergents must not contain abrasive substances or substances of acid/corrosive nature. In case of lack of appropriate detergents it is sufficient to clean the cooking chamber with a sponge soaked in warm soapy water or warm water and a little vinegar. Rinse with plenty of water (use the suitable shower if available) and dry well with a soft cloth. The side grilles must be cleaned separately and fitted back on. When cleaning is completed leave the oven door slightly open.

4.2 Semi-automatic cooking chamber cleaning

Spray specific degreaser for stainless steel on the internal walls of the cooking chamber, on the side grilles, on the fan covers (do not spray onto the fans through the grille) and on the internal door glass.

Let the product act for about 20 minutes with the door closed.

switch the oven on adjusting the temperature at 100-120°C.

Run a cycle with 100% steam (automatic humidifier knob in position "5") for about 15 minutes.

Upon completing the cycle switch off the oven, let the cooking chamber cool and rinse it with plenty of water (use the suitable shower if available).

Dry by running a heating cycle adjusting the temperature at 180-200°C for about 10 minutes (repeat the cycle if necessary).

When cleaning is completed leave the oven door slightly open.

4.3 Cleaning the fans

The fans must be regularly cleaned with appropriate descaling products. All their parts must be thoroughly cleaned, eliminating any limescale. The fan cover must be removed to access fans. When cleaning is completed fit the cover back on operating in reverse order.

4.4 Cleaning the door gasket

For hygienic and functional reasons it is good practice to clean the door gasket at the end of every day the oven is used. It must be accurately washed with warm soapy water. It must be rinsed and dried with a soft cloth. Any scaling or food residues must be removed with special care, without using sharp metal tools that might irreparably damage the gasket.

4.5 Cleaning the door

The internal glass of the cooking chamber door may be cleaned using the same type of degreaser used for manually cleaning the cooking chamber; otherwise, a normal (non toxic) glass cleaning product may be used. A common glass detergent may be used also to clean the external door glass. In any case one may simply use warm soapy water. After rinsing dry the glass surface well with a soft cloth.

Should opaque spots form between the two glass panes, these may be removed as they are inspectable.

4.6 Cleaning the external casing

The outer steel surfaces must be cleaned with a cloth soaked in warm soapy water or mixed with a little vinegar, they must be rinsed well and dried with a soft cloth.

Should you wish to use specific products on the market, these must comply with the cleaning requirements set out in the "Information for the user" paragraph.

It is worth remembering that the counter supporting the appliance, or the floor surrounding the appliance area, should also be cleaned without using acid corrosive substances (e.g. muriatic acid) since the vapours released by them might corrode and deteriorate the outer steel shell and cause irreparable damage to the electrical components inside the appliance.

4.7 Inactivity period

Should the appliance not be used for a long extent of time, it is good practice to disconnect it from the power supply (act on the safety magnetic circuit breaker located upstream of the appliance) and water supply. It is recommended to clean it with care internally (cooking chamber) and externally, paying special attention to removing any salt residues which might lead to corrosion on the steel surfaces.

It is also recommended to protect the appliance with oil-based spray products (e.g. Vaseline oil) which form an effective protective film when sprayed on the surfaces.

Leave the door of the cooking chamber ajar.

Adequately covering the appliance, finally, allows it to be protected from dust.

5. MAINTENANCE INSTRUCTIONS

A periodic check (at least once a year) of the appliance contributes to extending its service life and assures proper operation.

Any maintenance operation on the appliance must only be done by highly qualified personnel trained in the operations being performed and authorised by **TECNOEKA**. Operations must be carried out in accordance with the safety regulations in force in the country where the appliance is installed, pursuant to the regulations relative to plants and to workplace safety.

Before carrying out any maintenance on the appliance it must be disconnected from the mains and allowed to cool down.

The Manufacturer is not responsible for any appliance faults caused by defective maintenance.

5.1 Access to the components for inspection

Removing the back;

- Tangential motor (on the back)
- Circular resistors
- Radial motors
- Humidification solenoid valve
- Humidification piping/fittings unit

Togliendo il fianco destro:

- Door microswitch
- Control thermostat bulb
- Contactors
- Power supply terminal board
- Hood terminal board
- Safety thermostat
- Capacitors
- LED power supply
- Power board

Removing the control protection box (on door):

- Display TFT
- Led bar

5.2 Safety thermal devices

The appliance is equipped with a (manually reset) safety thermostat, to protect against excessive and hazardous overheating which might accidentally occur inside it. If the safety thermostat is activated, the power supply to the appliance is cut off.

The safety thermostat is located inside of the appliance.

Important

Safety thermostat should only be reactivated after eliminating the anomaly that caused them to trip. This can only be done by a Service technician.

5.3 Replacing the cooking chamber gasket

The cooking chamber gasket has a rigid profile with retaining fins. This profile must be inserted in the suitable perimeter seat on the " front " of the chamber.

To replace the gasket, simply remove the used one from its seat (pull tightly near the 4 corners) and, after cleaning any impurities from the seat, insert the new gasket (to facilitate the assembly, it is recommended to wet the profile of the gasket with soapy water).

6. TROUBLESHOOTING

Type of fault	Cause of the fault	Corrective action
Control panel warning lights totally off (The oven does not work)	- Non-compliant connection to the power mains	- Check the connection to the mains
	- No mains voltage	- Restore the power supply voltage
	- Safety thermal device triggered	- Contact a skilled technician
Cooking cycle set: the oven does not work	- Door open or ajar	- Close the door properly
	- Door microswitch damaged	- Contact a skilled technician
Automatic humidifier active: no humidity/steam production in the cooking chamber	- Non-compliant water mains connection	- Check the connection to the water mains
	- Closed stopcock	- Check the cock
	- Obstructed water inlet filter	- Clean the filter
	- Damaged water inlet solenoid valve	- Contact a skilled technician
Closed door: steam escapes through the gasket	- Non-compliant gasket assembly	- Check gasket assembly
	- Damaged gasket	- Contact a skilled technician
	- Handle "nose" adjusted incorrectly	- Contact a skilled technician
The oven does not cook evenly	- One of the motors is down or operates at low speed	- Contact a skilled technician
	- The motors do not reverse direction	- Contact a skilled technician
	- Resistor not powered or damaged	- Contact a skilled technician
Lamp (LED) in the cooking chamber does not work The thermal safety device is activated continuously	- Lamp (LED) damaged	- Replace the lamp (LED)
	- Damaged device	- Contact a skilled technician
The thermal safety device is activated continuously	- Damaged device	- Contact a skilled technician
	- Control thermostat damaged	- Contact a skilled technician

7. POSSIBLE ALARMS

Identify the causes that inhibit the oven operation

	Type of alarm	Cause of the alarm	Effect	Corrective action
E01	Temperature probe not detected Impossible to start cooking	Cooking chamber probe-electronic board/ microprocessor connection down	Impossible to start cooking	Contact a skilled technician
		Damaged cooking chamber probe		
E02	Core probe not detected Impossible to start cooking	Core probe-electronic board/microprocessor connection interrupted.	It is not possible to activate a cooking cycle which requires to set the "core temperature" parameter	Contact a skilled technician
		Damaged needle shaped core probe.		
E03	Blackout	Power outage for a period of time during the cooking cycle	Oven operation deactivated. When power is restored, the display shows the screen of the cooking program that is running	Reactivate the cooking program
E04	USB error	USB stick not readable/damaged	Operation cannot be performed	Replace the USB stick
		USB socket-board connection interrupted		Contact a qualified technician

7. TECHNICAL SUPPORT

Before leaving the factory this appliance has been calibrated and tested by experienced and skilled personnel in order to obtain the best operating results. Any repair or calibration must be carried out with the utmost care and attention, using only original parts.

That is why it is required to always contact the Dealer who has sold the appliance or our nearest Technical Support Centre, specifying the kind of failure and the model of the appliance you have. The parts required for adaptation to different types of gas are provided with the appliance hence supplied upon sale or delivery.

For servicing needs the user may contact Tecnoeka on the numbers shown on the cover, or refer to the website www.tecnoeka.com.

8. DISPOSAL OF THE APPLIANCE

In accordance with Directive 2012/19/EU on the disposal of waste electrical and electronic equipment, the crossed-out wheeled bin symbol on the equipment indicates that the product was placed on the market after 13 August 2015, and that at the end of its services life it must be disposed of separately from other waste.

At the end of the appliance's service life, the user must, therefore, deliver it to the appropriate centres (recycling centres) for the separate collection of electrical and electronic waste.

All TECNOEKA appliances are made of recyclable metal materials (stainless steel, galvanised sheet metal, iron, copper, aluminium, etc.) which make up more than 90% of the total weight of the appliance. Before disposing of the appliance, it is recommended to make it unusable by removing the power supply cable and removing the mechanism for closing compartments and/or openings, if any.

The separate waste collection and subsequent treatment, recovery and disposal, are conducive to the production of equipment with recycled materials and reduce the negative effects on the environment and health possibly caused by incorrect waste handling. Illegal disposal of the product by the user entails the application of administrative penalties.



9. CONVENTIONAL WARRANTY

The Tecnoeka product is designed for food use only and is covered by warranty according to law (art. 1490 and subsequent articles of the Italian Civil Code) for Professional Customers or customers who purchase from the Dealer with a VAT number. The Tecnoeka product is professional and certified according to IEC EN 60335-1 and can only be sold to professional users.

With the exclusion of any additional warranty, the Vendor agrees to repair, at its sole discretion, only those parts of the products that prove to be tainted by an original fault as long as, subject to forfeiture, the customer has reported the fault within 12 months from the date of purchase and reported the defect within 8 days from the date of discovery, in writing, attaching a copy of the invoice, receipt or tax receipt as proof of purchase.

Including the event in which the customer is unable to produce the invoice, receipt or tax receipt as proof of purchase, meaning that the terms outlined above are not complied with, the warranty is expressly forfeited in the following cases:

- 1) Faults or breakdowns of components caused by transport.
- 2) Damage deriving from inadequate electrical, hydraulic and gas supply systems compared to that provided in the installation manual, or anomalous operation of these systems.
- 3) Damage deriving from incorrect product installation, or installation not carried out in accordance with the installation manual and, in particular, damage due to the inadequacy of the flues and drains that the product is connected to.
- 4) Using the product for purposes other than its intended use, as specified and resulting from the technical documentation issued by Tecnoeka.
- 5) Damage due to using the Product in a manner that is not in line with the instructions in the use and maintenance manual.
- 6) Tampering with the product.
- 7) Product adjustment, maintenance and repair activities carried out by unqualified personnel.
- 8) The use of non-original spare parts or not authorised by Tecnoeka.
- 9) Damage or defects caused by negligent and/or imprudent use of the product, or in contrast with the instructions set forth in the use and maintenance manual.

10) Damage caused by fire or other natural events and, in any case, by unforeseeable circumstances or any other cause beyond the manufacturer's control.

11) Damage to components subject to normal wear that require periodic replacement.

Also excluded from the warranty: painted or enamelled parts, knobs, handles, mobile or removable plastic parts, light bulbs, glass parts, gaskets, electronic parts and any accessory parts, transport fees from the consumer, end user and/or buyer's location to Tecnoeka srl, and vice versa. Replacement costs of the oven and relative installation expenses are also excluded from the warranty. The warranty does not cover Products purchased as used or from third parties who are not connected to or authorised by Tecnoeka.

TECNOEKA SRL shall not be held liable for damage, either direct or indirect, caused by a product fault or as the result of the forced suspension of operation.

Repairs under warranty do not result in the extension or renewal of coverage.

Components replaced under warranty are, in turn, covered by a 6-month warranty from the shipping date, certified by the transport document issued by Tecnoeka.

No-one is authorised to change the warranty terms and conditions or to issue others, neither verbal nor written.

10. AVAILABILITY AND SUPPLY OF SPARE PARTS

Tecnoeka srl keeps and ensures the availability of spare parts for a maximum of 24 months from the date of sale of the finished product to the dealer. Availability cannot be guaranteed after said period.

11. APPLICABLE LAW AND COMPETENT COURT

Supply relationships will be governed by Italian law, with the express exclusion of the private international law standards and the Vienna Convention on Contracts for the International Sale of Goods of 11.4.1980. Any dispute will be settled exclusively by the Court of Padua.

Without prior notice and liability for Tecnoeka Srl, the products presented in the manual may be subject to technical and design changes for the purposes of improvement, without affecting the essential features relating to operation and safety. Tecnoeka Srl shall not be held liable for any inaccuracy due to printing or clerical errors affecting instruments, and in the technical and commercial description of its products to customers.



Tecnoeka srl

via Marco Polo, 11 - 35010 Borgoricco, Padova - Italy
Tel. +39.049.5791479 - Tel. +39.049.9300344 - Fax +39.049.5794387

email

info@tecnoeka.com - tecnoekasrl@pec.it

web site

tecnoeka.com